



为您的产品保驾护航

PRODUCT DATASHEET

Electro-Static Discharge

JEN1006-24V-ULC ESD

## Features

- Ultra small package: 1.0x0.6x0.5mm(DFN1006)
- Ultra low capacitance: 0.3pF typical
- Ultra low leakage: nA level
- Operating voltage: 24V
- Low clamping voltage
- 2-pin leadless package
- Complies with following standards:
  - IEC 61000-4-2 (ESD) immunity test
    - Air discharge:  $\pm 15\text{kV}$
    - Contact discharge:  $\pm 8\text{kV}$
  - IEC61000-4-5 (Lightning) 1.5A (8/20 $\mu\text{s}$ )
- RoHS Compliant

## Applications

- Cellular Handsets and Accessories
- Display Ports
- MDDI Ports
- USB Ports
- Digital Visual Interface (DVI)
- PCI Express and Serial SATA Ports

## Schematic Diagram

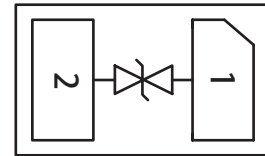

## Pin Description



## Limiting Values( $T_A = 25^\circ\text{C}$ , unless otherwise specified)

Symbol	Parameter	Conditions	Min	Max	Unit
V <sub>ESD</sub>	Electrostatic Discharge Voltage	IEC 61000-4-2;Contact Discharge	-	$\pm 8$	kV
		IEC 61000-4-2;Air Discharge	-	$\pm 15$	kV
P <sub>PP</sub>	Peak Pulse Power	t <sub>p</sub> =8/20 $\mu\text{s}$	-	80	W
I <sub>PP</sub>	Rated Peak Pulse Current	t <sub>p</sub> =8/20 $\mu\text{s}$	-	1.5	A
T <sub>J</sub>	Operating Temperature Range	-	-55	125	$^\circ\text{C}$
T <sub>stg</sub>	Storage Temperature Range	-	-55	150	$^\circ\text{C}$

## Electrical Characteristics( $T_A = 25^\circ\text{C}$ , unless otherwise specified)

Symbol	Parameter	Conditions	Min	Typ.	Max	Unit
V <sub>RWM</sub>	Reverse Working Voltage	T <sub>A</sub> =25 $^\circ\text{C}$	-	-	24	V
V <sub>BR</sub>	Breakdown Voltage	I <sub>T</sub> =1mA;T <sub>A</sub> =25 $^\circ\text{C}$	26.5	-	-	V
I <sub>R</sub>	Reverse Leakage Current	V <sub>RWM</sub> =24V	-	-	0.5	$\mu\text{A}$
V <sub>C</sub>	Clamping Voltage	I <sub>PP</sub> =1A(8x20 $\mu\text{s}$ pulse)	-	-	40	V
V <sub>C</sub>	Clamping Voltage	I <sub>PP</sub> =1.5A(8x20 $\mu\text{s}$ pulse)	-	-	53	V
C <sub>J</sub>	Junction Capacitance	V <sub>R</sub> =0V,f=1 MHz	-	0.30	-	pF

Typical Characteristics

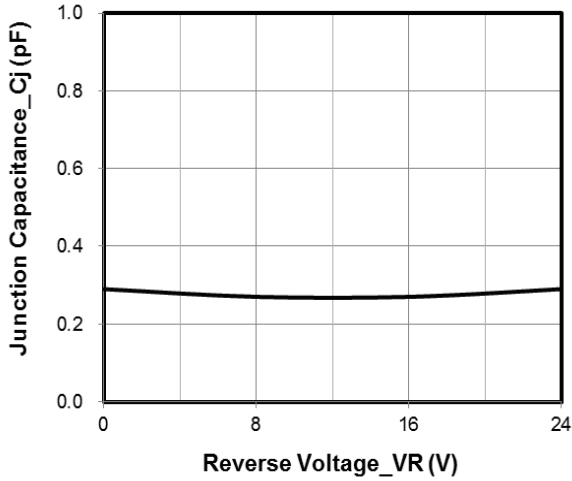

Junction Capacitance vs. Reverse Voltage

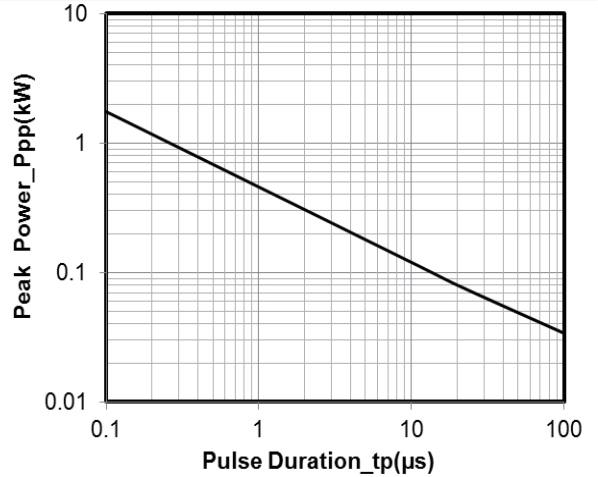

Peak Pulse Power vs. Pulse Time

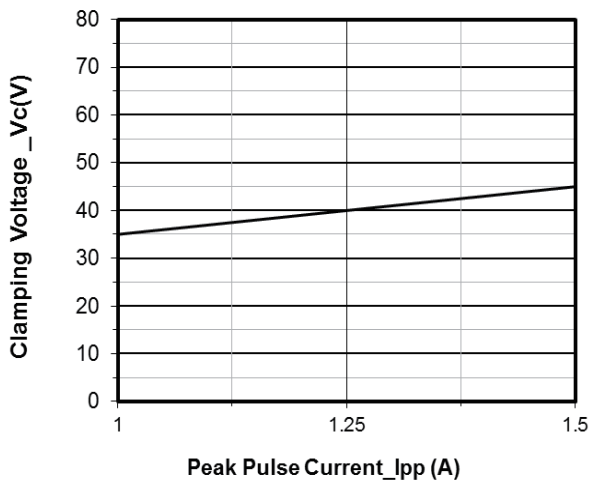

Clamping Voltage vs. Peak Pulse Current

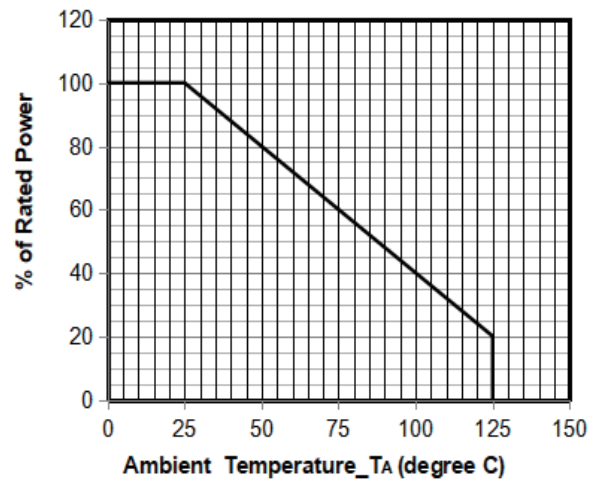

Power Derating Curve

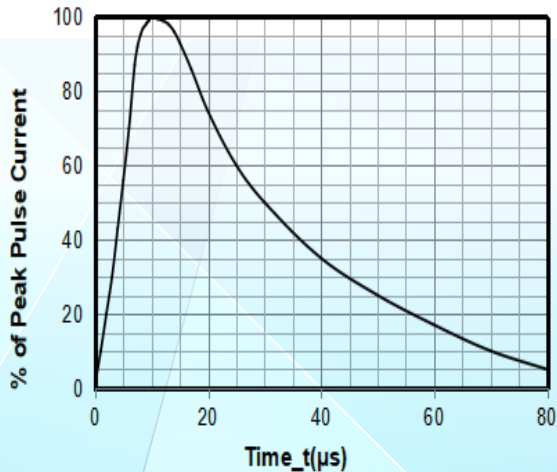

8 X 20 μs Pulse Waveform

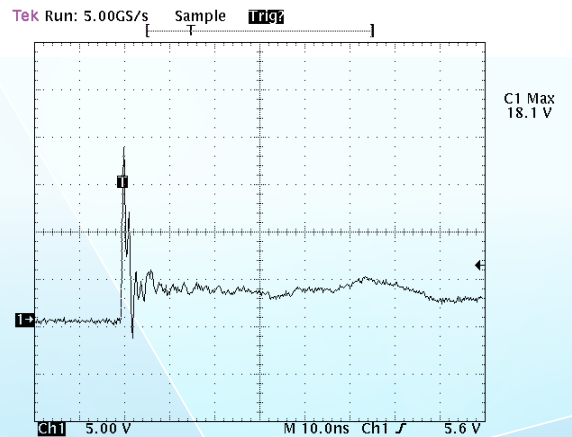

Note: Data is taken with a 10x attenuator  
ESD Clamping Voltage  
8 kV Contact per IEC61000-4-2

Physical Dimensions(mm.)

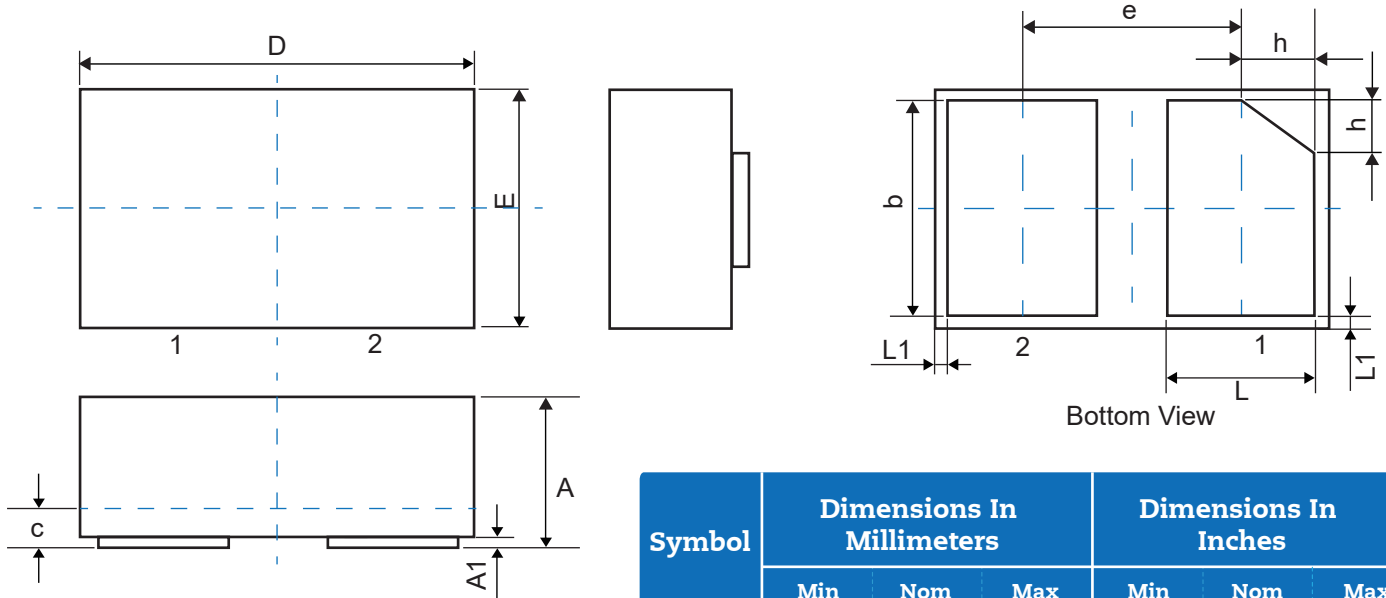

Symbol	Dimensions In Millimeters			Dimensions In Inches		
	Min	Nom	Max	Min	Nom	Max
A	0.45	0.50	0.55	0.018	0.020	0.022
A1	0.00	0.02	0.05	0.000	0.001	0.002
b	0.45	0.50	0.55	0.018	0.020	0.022
c	0.12	0.15	0.18	0.005	0.006	0.007
D	0.95	1.00	1.05	0.037	0.039	0.041
e	0.65 BSC			0.026 BSC		
E	0.55	0.60	0.65	0.022	0.024	0.026
L	0.20	0.25	0.30	0.008	0.010	0.012
L1	0.05 REF			0.002 REF		
h	0.07	0.12	0.17	0.003	0.005	0.007

Suggested Land Pattern

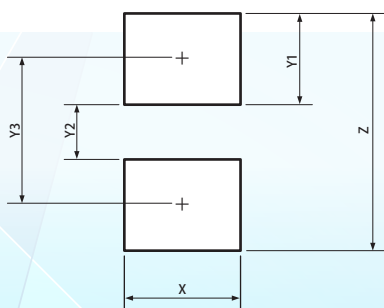

Symbol	Dimensions	
	Millimeters	Inches
X	0.60	0.024
Y1	0.50	0.020
Y2	0.30	0.012
Y3	0.80	0.032
Z	1.30	0.052

Packaging Quantity

Part Number	Size(mm)	Delivery Form	Delivery Quantity
JEN1006-24V-ULC	1.0x0.6x0.5	7" T&R	10,000

### Soldering Parameters

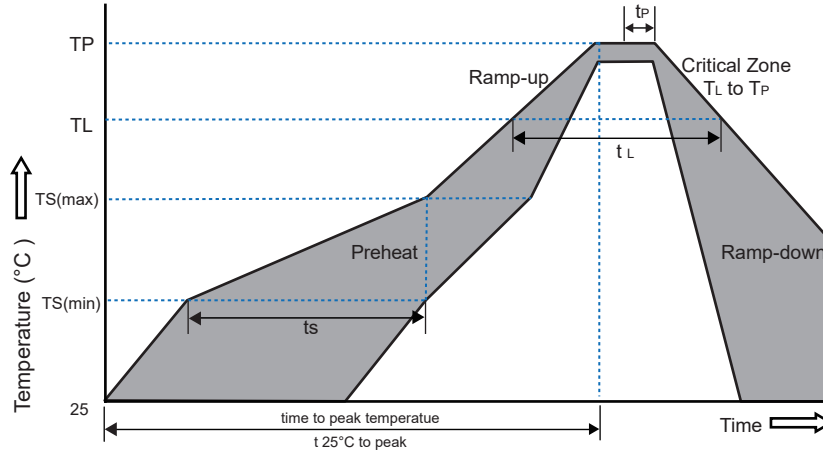

Reflow Condition		Pb-Free Assembly
Pre-heat	-Temperature Min( $T_{s(min)}$ )	+150°C
	-Temperature Max( $T_{s(max)}$ )	+200°C
	-Time(Min to Max)( $t_s$ )	60~180 secs.
Average ramp up rate (Liquid us Temp( $T_L$ ) to peak)		3°C/sec. Max
Ts(max) to $T_L$ - Ramp-up Rate		3°C/sec. Max
Reflow	-Temperature( $T_L$ )(Liquid us)	+217°C
	-Temperature ( $t_L$ )	60~150 secs.
Peak Temp ( $T_p$ )		+260(+0/-5)°C
Time within 5°C of actual Peak Temp ( $t_p$ )		30 secs. Max
Ramp-down Rate		6°C/sec. Max
xTime 25°C to Peak Temp (TP)		8 min. Max
Do not exceed		+260°C

### Part Number System

## JE N1006 - 24V - UL C

